

BOW AND TWIST

Conditions of bow and/or twist, when combined with lighting from an unfavorable angle or misalignment during installation, detract from the cosmetics of a masonry structure. Bowing can be defined as an overall out-of-plane condition in which two opposite edges of a component, such as a panel, fall in the same plane and the portion of the panel between the edges is out of plane. Twisting (or warping) is a condition in which the corners of the panel do not fall within the same plane, resulting in overall out-of-plane curvature of surfaces. Below are two drawings illustrating bow and twist. While bow and twist are not structural issues, but rather aesthetic ones, the Cast Stone Institute's Standard Specification for Architectural Cast Stone defines strict limits for both conditions.

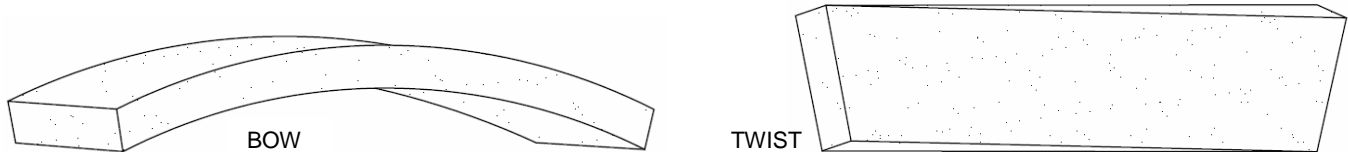

The Standard Specification for Architectural Cast Stone states, "Warp, bow or twist of units shall not exceed length/360 or $\pm 1/8$ in., whichever is greater." If the pieces are 45 inches long or less, $\pm 1/8$ " applies. For longer pieces, divide the length by 360.

Measurement of Bow:

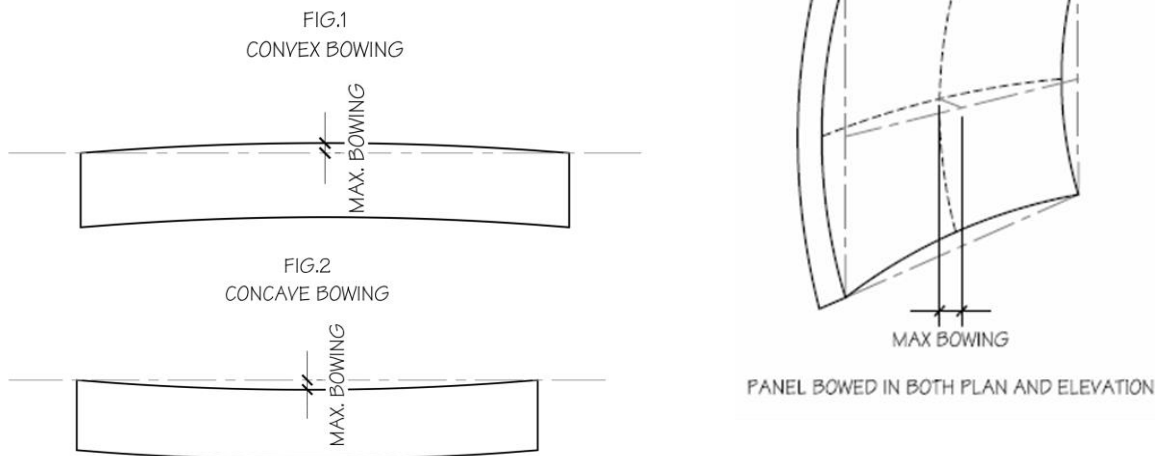

A problem encountered in the field is that convex bowing cannot be measured as shown after the stone has been installed. To measure convex bowing after installation, shims and a straight edge are employed.

Case #1: With $1/8$ " shims at both ends, the straight edge doesn't touch the stone. Therefore the bow is less than $1/8$ " and the stone is within specification.

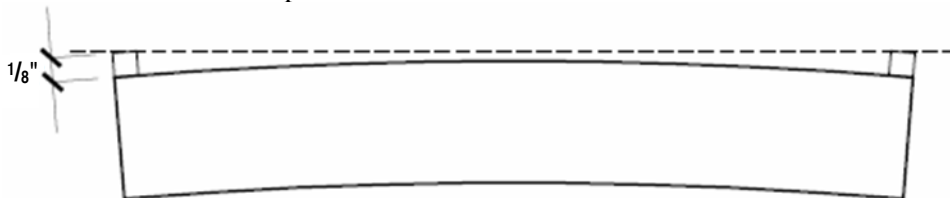

Case #2: With 1/8" shims at both ends, the straight edge just touches the stone. The straight edge cannot be rocked by applying more pressure to either end. Therefore the bow is equal to 1/8" and the stone is within specification.

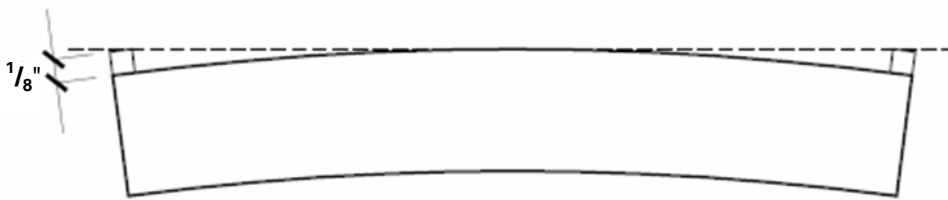

Case #3: With 1/8" shims at both ends, the straight edge can only touch one shim when in contact with the stone in the middle. The bow is greater than 1/8" and the stone is out of specification.

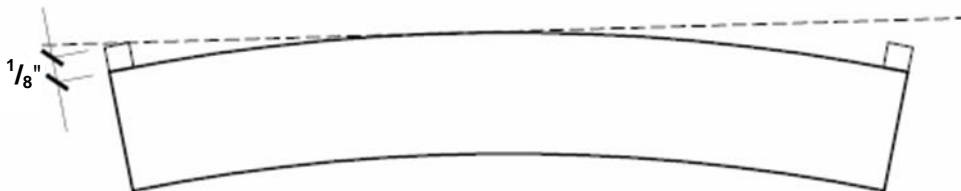

Measuring Case #3: To measure the bow in this stone, add additional equal shims to both sides until the straight edge touches both shims and the stone. The bow of the stones is equal to the amount of shim on either side, in this case, the bow is 3/16" and the stone is out of specification.



Measurement of Twist is done in a similar manner:

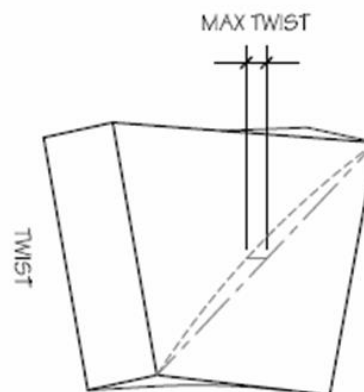
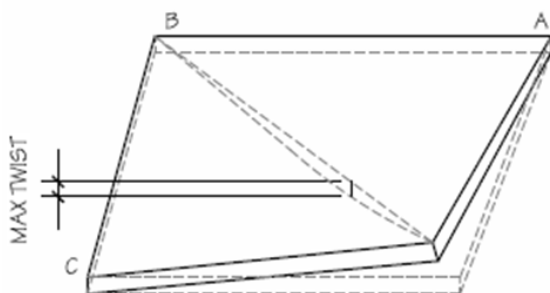

Shadow Lines:

Shadow lines are formed when an irregular surface is lighted from an angle. A typical installation specification for alignment of adjacent masonry units is $\pm 1/16''$ plus in-tolerance bowing or twisting of masonry units. Therefore, the total of installation and manufacturing tolerance can result in up to $3/16''$ alignment differences in adjacent units, and potentially more if the units are longer.

Under some lighting conditions, shadows will be cast which may make alignment seem to be much worse than actual and appear to be outside of specifications.



Notes: The photo on the left shows the large shadows that can arise from small, within specification, setting misalignment. The photo on the lower right shows the angle of the sun. Note that the stones on the side of the building in direct sunlight do not show any of these shadows.

Shadow Length Calculations:

This table shows the shadow lengths of a $1/16''$ projection at several lighting angles.

SUN ANGLE	COTANGENT	SHADOW LENGTH OF 1/16" PROJECTION
1 degree	57.29	3.581
2.5 degrees	22.9038	1.431
5 degrees	11.4301	0.714
10 degrees	5.6713	0.354
80 degrees	0.1763	0.011

When lit from a small angle, the shadow which is cast can be more than 50 times the amount of projection!

Shadows Cast by Graded Sand:

These photos of sieved masonry sand have been taken at small lighting angles (about 2° and 1°).

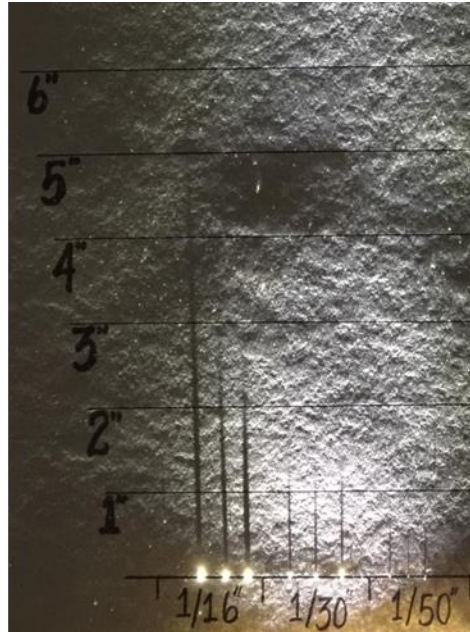
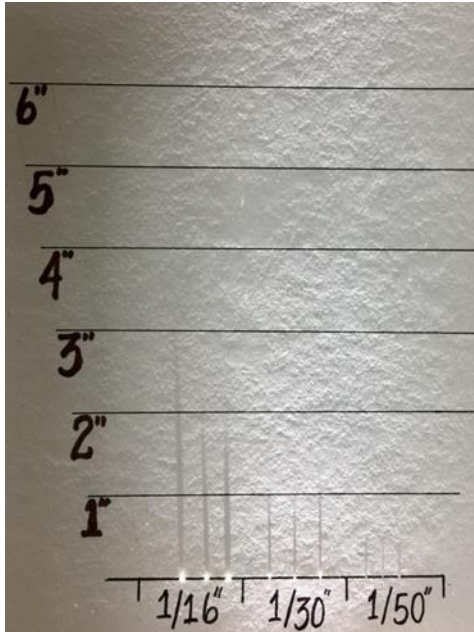

- The sand labeled “1/16” passed through a sieve with 1/8” mesh and did not pass through a sieve with 1/16” mesh. These particles are therefore smaller than 1/8” and larger or equal to 1/16”
- Similarly, the sand labeled “1/30” passed through a sieve with 1/16” mesh and did not pass through a 1/30” sieve.
- The sand labeled “1/50” passed through 1/30” and not 1/50”.
- Note that shadows cast from in-specification masonry can easily exceed one inch and in extreme lighting conditions can be more than five inches long!

The Cast Stone Institute’s dimensional specifications on bow and twist are just as important as its specification on length. Cast stone producers must strictly adhere to the CSI specification limits on bow and twist. In addition, masons must be careful to minimize installation misalignment and to exercise care in “humoring” allowable manufacturing variances during installation. Even with the best practices, certain lighting conditions may cause masonry units to appear to be out of specification.

This Technical Bulletin addresses generally accepted practices, methods and general details for the use of Architectural Cast Stone. This document is designed **only as a guide** and is **not** intended for any specific application or project. It is the responsibility of design and construction professionals to determine the applicability and appropriate application of any detail to a specific project based on professional judgment, specific project conditions, manufacturer’s recommendations and solid understanding of product characteristics. The Cast Stone Institute makes no express or implied warranty or guarantee of the techniques or construction methods identified herein. Technical references shall be made to the edition of the International Building Codes for the location of the structure, the latest edition of the TMS 402/406 Masonry Standards document and TMS 404, 504, 604 Standards for Design, Fabrication and Installation of Architectural Cast Stone.

The Cast Stone Institute (CSI) is a not-for-profit organization created to advance the design, manufacture and use of Architectural Cast Stone. To further this goal, the CSI continually disseminates information to targeted construction industry audiences through presentations,